

**EXPERIMENTAL AND NUMERICAL WORKS
ON AN ALTERNATIVE STRENGTHENING TECHNIQUE
FOR IRREGULAR RC BUILDINGS**

FARUK KARADOĞAN

Civil Engineering Faculty of Istanbul Technical University (ITU)
80626 Maslak – Istanbul, TURKEY

ERCAN YUKSEL

Civil Engineering Faculty of Istanbul Technical University (ITU)
80626 Maslak - Istanbul TURKEY

WEIEL MOURTAGE

Civil Engineering Faculty of Istanbul Technical University (ITU)
80626 Maslak – Istanbul, TURKEY

KEREM ALMAC

Civil Engineering Faculty of Istanbul Technical University (ITU)
80626 Maslak - Istanbul TURKEY

ABSTRACT

There are tremendous amount of irregular low rise low cost vulnerable buildings in the earthquake prone areas all over the world. Any kind of plan irregularity, member irregularity and/or irregularities in height exist in that buildings which have to be upgraded at least to the level of *collapse prevention*, in a way that people and their government could support it. It has been proven that properly oriented two walls in each direction with reasonable dimension for each 100 m² floor area of building will be enough to resist the expected redesign earthquake forces even the extensive damage can not be prevented.

If they are examined by the existing evaluation methods, those buildings, are not able to satisfy the minimum criteria valid for FEMA, EC8 1.4 or Japanese Standards or others. On the other hand all these buildings have to be used till they totally damaged or collapsed. New techniques which will transform the existing partitioning walls to lateral and vertical load bearing walls, or new techniques for having low cost new walls are under experimental and theoretical investigation in last decade in Istanbul Technical University. For increasing the efficiency of the findings and to cut their cost, more attention started to be paid to the connection of the new lateral load resisting element to the peripheral rc members including the foundation. A parametric work has been carried out to justify a set of complementary

experimental work. The purpose of this paper is simply to review the early results of this work.

INTRODUCTION

New shear wall indentation techniques are widely used all over the world either for strengthening of a damaged reinforced low rise building or for retrofitting the similar existing buildings, which are generally irregular in plan.

There are several important criticised aspects of this kind of techniques;

1. The excessive lateral rigidity of shear walls accompanying with relatively big foundations associated with relatively smaller rotation, makes the fundamental period of structure shorter. Hence, generally bigger lateral loads are imparted to the structure in redesign process, which makes the retrofitting unaffordable for the people who are leaving in such vulnerable buildings which are strongly expected to develop total collapse even during a moderate earthquake.
2. The overall displacement ductility of the building becomes small after having added the shear walls. Since that factor is welcome by most of the codes to reduce the elastic earthquake forces to the design load levels, this becomes another reason for having expensive solutions.

Since it is practically very difficult to lessen the rotation at the bottom of a shear wall which has only limited amount of axial force on it but big overturning bending moment and shear, the other extreme boundary condition which is hinge versus fixed end, becomes interesting to work on, even though the shear wall, in a certain extent, is elastically fixed in reality.

Theoretically hinged shear wall assumption at the bottom makes the lateral rigidity of the structure smaller and do not attract the bending moment together with shear force, and let the structure free to resist the overturning moment by, so called, *frame action* which composes of an axial force couples in opposite directions in adjacent columns to the wall. It should not be forgotten that these axial forces will be transferred through the shear forces in the part of the beams where no shear wall exist, and the increased column axial force in one of the two columns should be carried by these elements and if necessary jacketing should be applied to these elements.

For the justification of the above mentioned expected, in one sense, controversial structural behaviour, an experimental pilot program has been initiated in the Structural and Earthquake Engineering Laboratory of Istanbul Technical University (STEELAB) as a part of a substantial experimental program launched for strengthening of existing buildings, in the year of 2002. A set of numerical analyses have been carried out prior to the initiation of testing program to predict the possible response of specimens, depending on the early experimental works completed in the same laboratory on the shear dominant behaviour of panel building, [1]. Since the beam theory is not always representative for the actual behaviour of shear wall acting together with frame elements, a powerful tool is necessary especially for reflecting the nonlinear behaviour of finite elements made from nonhomogenous material. A smeared plane stress finite element with an elasticity matrix based on experimentally modified shear

stress-shear strain relationship has been proposed, [2], and the same technique has been employed in this investigation. The broad experimental program and some of the details of one of the tests and the early findings of the numerical analyses, are presented in the following paragraphs.

EXTENSIVE EXPERIMENTAL PROGRAM LAUNCHED IN ITU

Recently one of the most important problem for structural engineers became to find out the most effective and reliable methods of strengthening of reinforced concrete residential and industrial buildings which are generally irregular structures with huge amount of eccentricities in the plan. Since the material characteristics, structural features and engineering practice are quite different from country to country, more experimental research accompanied by theoretical works are almost inevitable to take into account the local factors even though some of the basic principals are general for any kind of strengthening procedure.

Not only nation wide cooperative works but international complementary works gained relative importance also, as far as the limited national research sources are concerned. Ways should be modified in a cooperative manner to answer the following questions as quickly as possible;

1. Computerised assessment techniques based on *vulnerability curves* which are automatically updated after having each execution, should be developed for regular and irregular buildings as well,
2. Altered structural behaviour due to any kind of shear walls added to the building and their foundation which may have different versions, should be investigated both in experimental and theoretical manners, preferably for multidirectional earthquake effects.
3. Easily applicable and relatively cheaper techniques to upgrade the lateral load resisting capacity of some of the most vulnerable residential low rise buildings, to the collapse prevention level, should be investigated. The prefabricated industrial buildings where the people who are living in vulnerable residential buildings, are working in, should also be upgraded to minimise the social catastrophe expected right after the earthquake.
4. The necessary experimental and theoretical works should be completed to justify the redesign force levels, the design principles and details of foundations for newly added shear walls and their connection to the existing elements. A short summary of the current research works in STEELAB is presented in Appendix #1.

Scale factors of the specimens and the capabilities of testing facilities, put certain limitations to the specimens prepared for displacement controlled static tests in ITU. National and international coordinated complementary works will have positive influence on getting more reliable experimental data in relatively short period. In this regard, complementary static, pseudo-dynamic and shaking table tests to the static tests planned in ITU may be the first step of new cooperative works.

In connection to all these explanation, a pilot test which composes of three specimens shown below has been selected for possible discussion, (Figure 1). Very light reinforcement mesh in

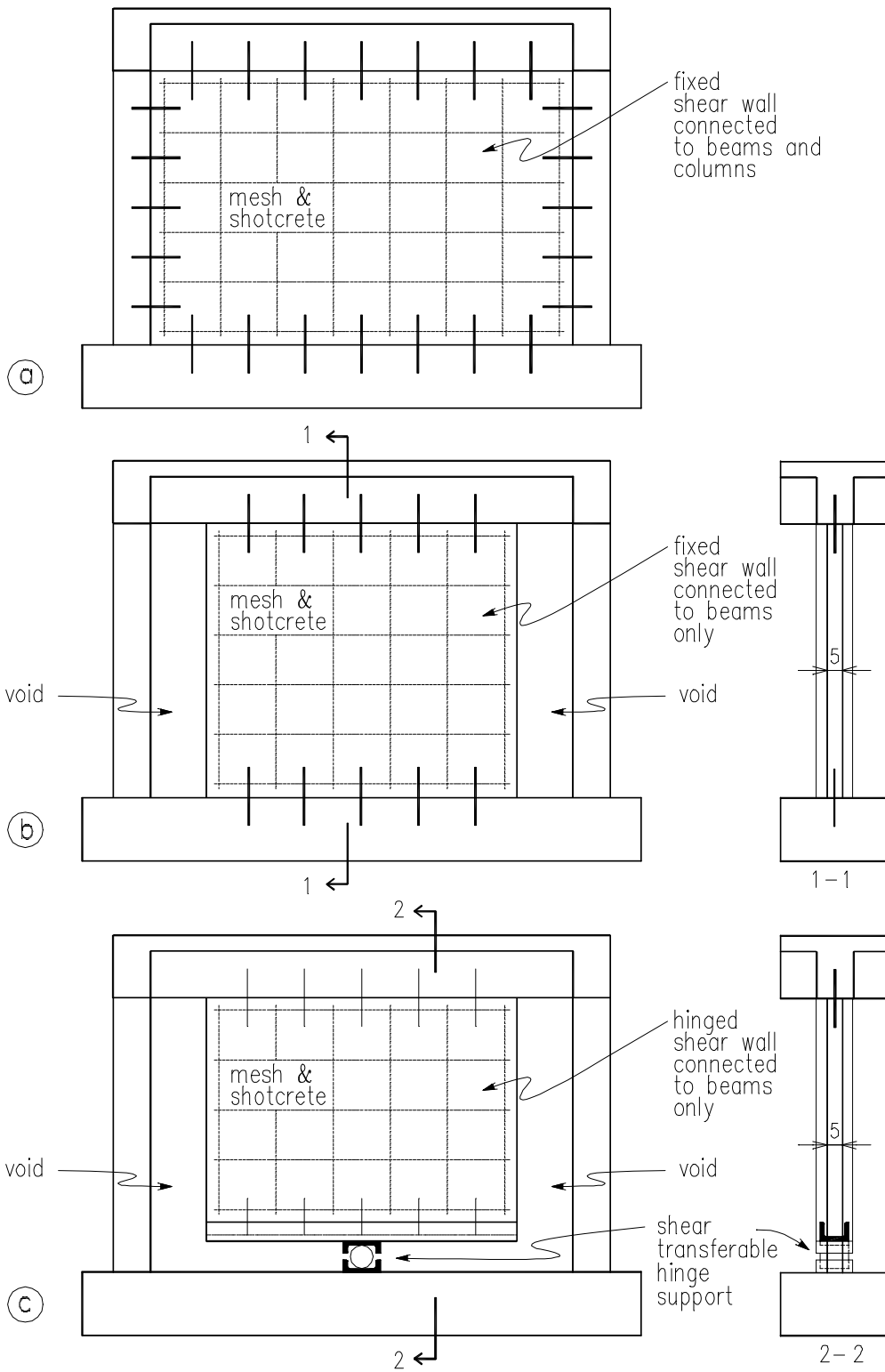

Figure 1

two direction, chemical anchors and shotcrete have been used to create the shear walls in the specimens a, b, c of Figure 1. The shear wall took part in Figure 1a has been fully connected to the existing frame, while the other two specimens shown in Figure 1b and 1c are connected to the beams only. And the hinge in Figure 1c which represents an extreme rotation of a foundation fictitiously has been designed so that it transfers shear force to the foundation as well. These three specimens have been fabricated and they have the highest priority for being tested in STEELAB. The mathematical models shown in Figure 2 have been used to predict the possible linear and nonlinear behaviour of the planar one storey one bay frames which can be considered as one of the substructures of a 3D building as it is decomposed in a way presented elsewhere [3].

PARAMETRIC WORKS CARRIED OUT

The expected better behaviour of added shear wall-frame system shown in Figure 1b to the system shown in Figure 1a is the additional sections or locations where more energy will be absorbed by the structure which can be expressed in terms of rotational and/or displacement ductility terms. This will be obtained in the expense of moment capacity provided by bottom section of newly added shear wall which means that a foundation not as big as the first case, is needed. The unrealistically extreme case of this solution is the shear wall demonstrated in Figure 1c where practically no moment is required to be transferred to the foundation but shear force.

The energy diagrams which indicate the ratio of virtual work of an element relative to the rest of the structure [4] given in Figure 3 and the internal force distributions presented in Table 1 can be compared for that purpose. If the ratios given in Table 1 is carefully examined it will be clear that;

1. Reasonable structural behaviour can be achieved by the shear wall with hinge end, hence, the cost of foundation can be cut down for having cheaper retrofitting which can be adopted to prevent the low cost housing against total collapse due to earthquake. The connection details etc., and the expected efficiency of this proposal should be verified by proper testing, before it is used.
2. Existing partitioning walls should be modified so that the modulus of elasticity and shear capacity should be improved. New cheaper techniques should urgently be tested.
3. A solution between the two cases designated as II and III will be test not only for shear transfer but to keep the axial forces of adjacent columns in a reasonable level so that additional jacketing should not be requested.

Opposite camber given prior to the construction of shear wall to the beam can be released after having hardened the concrete to increase the axial load on the wall which will have positive effect on shear capacity of the wall.

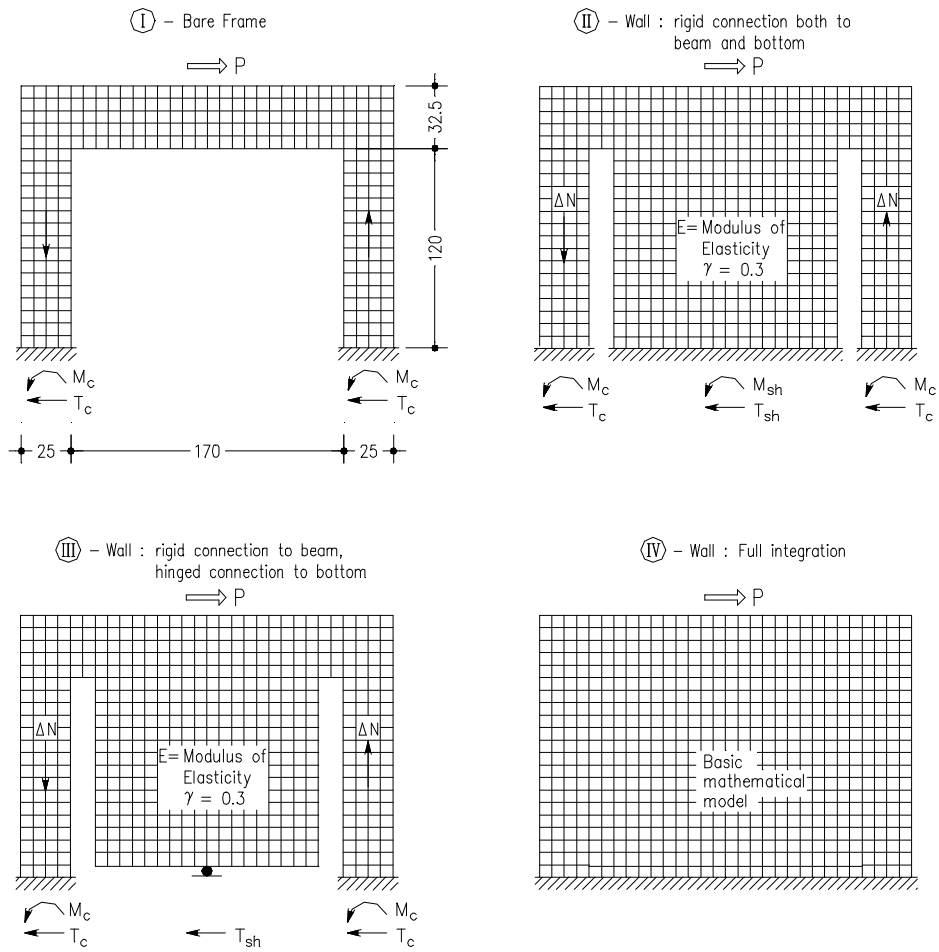

Figure 2

Table 1 Internal Force Distribution of the Bottom Sections

Structural Configuration	Internal Forces in terms of P the Lateral Load									
	Bending Moments				Shear Force				Axial Force	
	In column, M_c		In shear wall, M_{sh}		In column, T_c		In shear wall, T_{sh}		In column ΔN	
	E_1	E_2	E_1	E_2	E_1	E_2	E_1	E_2	E_1	E_2
I	0.33		-		0.50		-		0.36	
II	0.24	0.03	0.18	0.85	0.35	0.05	0.30	0.90	0.37	0.23
III	0.27	0.07	0.00	0.00	0.39	0.11	0.22	0.78	0.42	0.63

E_1 : 6000 kN/m²

E_2 : 270000 kN/m²

ν : poisson ratio

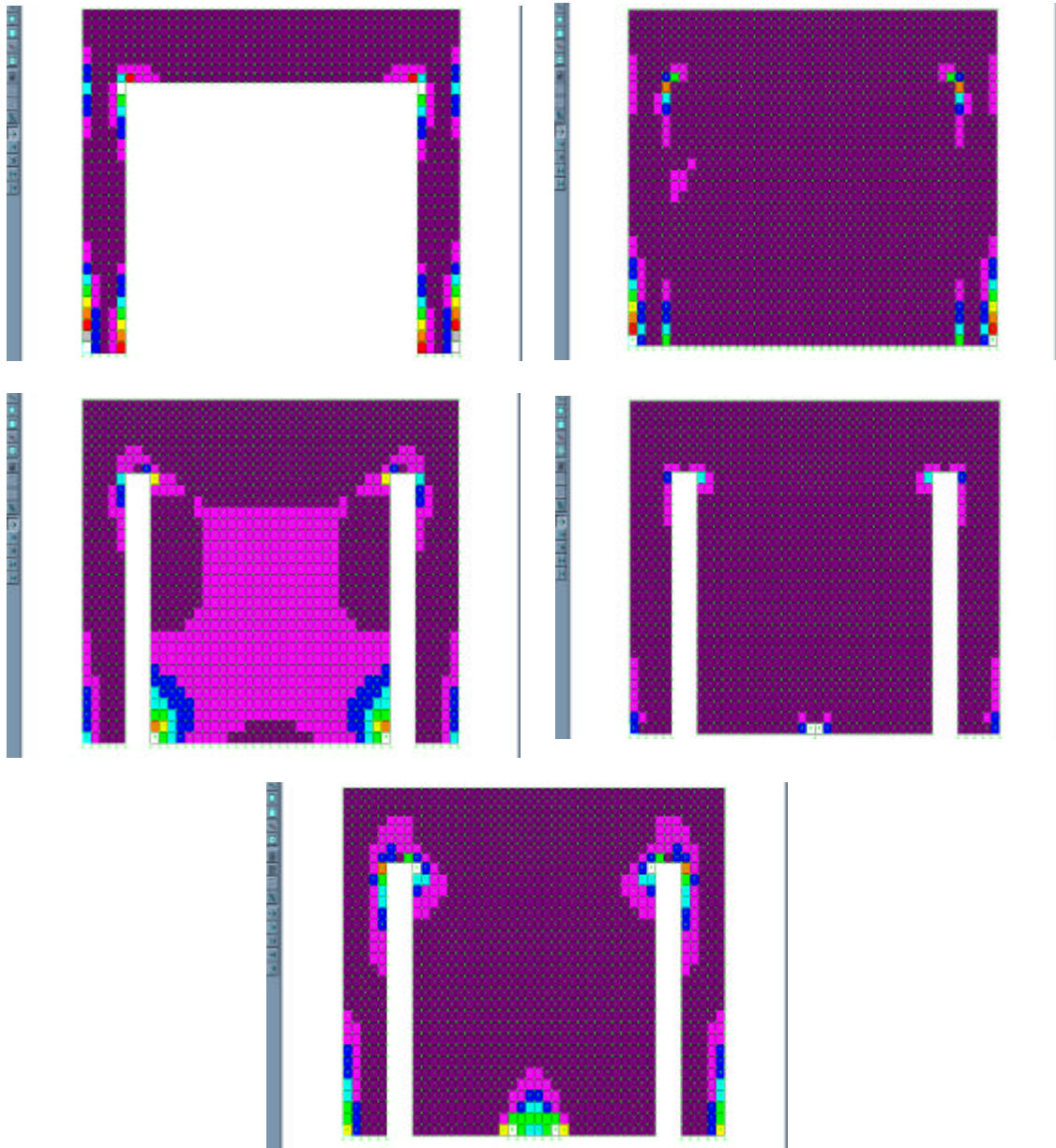

Figure 3

Another comparative example has been prepared and presented in Figure 4 to indicate the changes in overall behaviour of a multibay - multistorey frame retrofitted by shear walls with different type of connections to the structural elements and to the foundation. It is clear that the fundamental period of structures are getting smaller as it is expected, as much as it is integrated to the existing building and foundation, hence the earthquake forces imparted to the structure increase, Table 2. The lowest increment is achieved when the shear wall is let to free to rotate at the bottom where the wall is collecting the biggest shear force keeping the shear forces of other columns lower than the bare frame case, **I**. The axial forces of existing

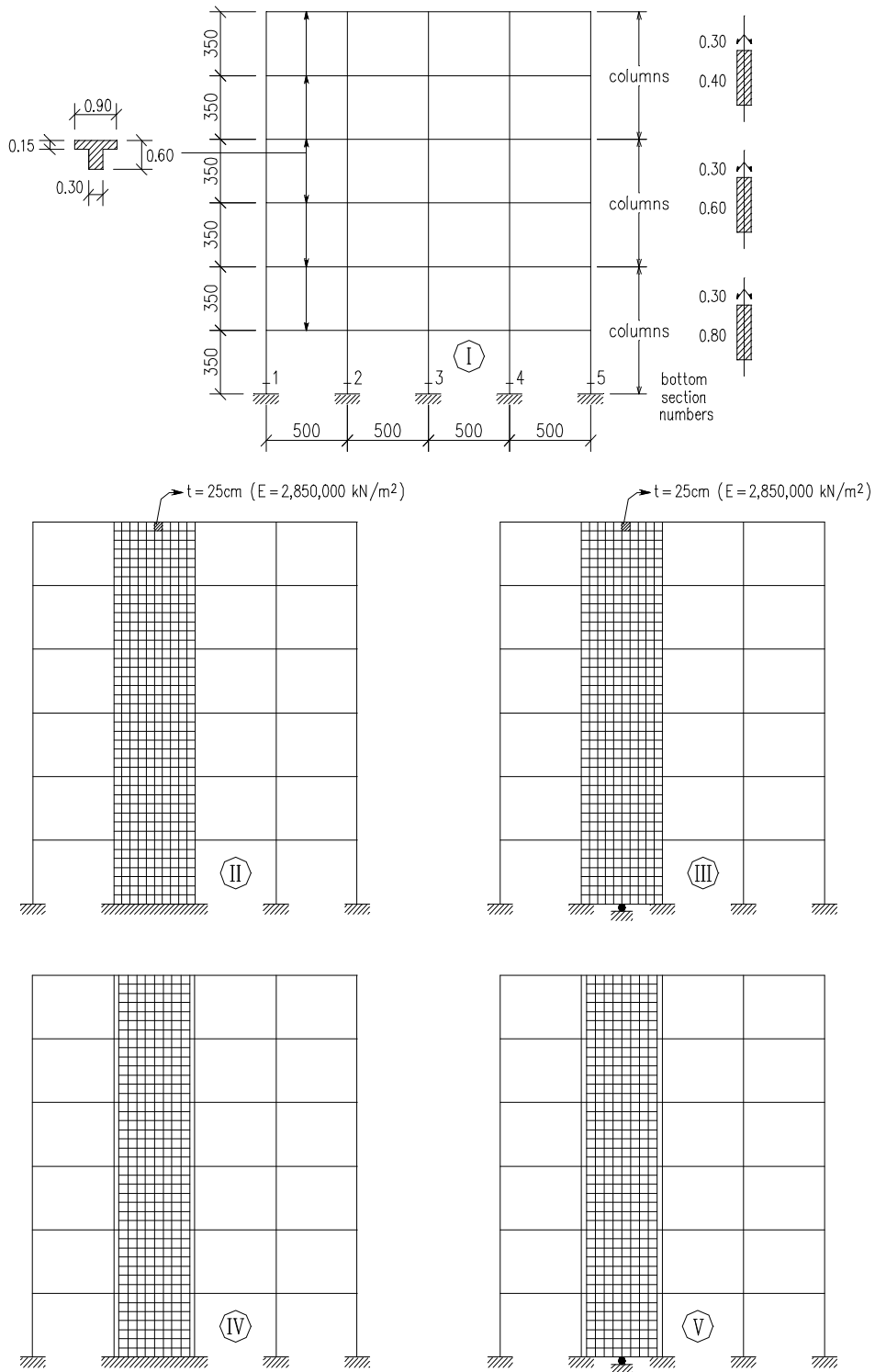

Figure 4

Table 2

Structure	T [sn] 1st Mode	Internal Forces at the Foundation Level																		
		Axial Force [kN]						Shear Force [kN]						Bending Moment [kNm]						
		1	2	3	4	5	Wall	1	2	3	4	5	Wall	Total	1	2	3	4	5	Wall
I	1,454	-888,7	-2063,0	-1922,4	-1881,0	-1768,0	x	104,0	130,2	128,5	128,6	115,1	x	605,4	207,0	237,6	233,4	237,1	220,1	x
II	0,421	-903,7	1646,5	-2726,1	-2072,4	-1433,2	-3330,0	11,0	66,3	98,6	14,6	15,5	1542,1	1748,0	21,9	36,6	49,5	26,0	27,0	9164,1
III	0,958	-496,3	x	x	-2507,1	-1520,4	-3835,8	93,4	x	x	106,5	77,2	829,8	905,9	166,5	x	x	181,8	147,8	0,0
IV	0,507	-1130,3	1034,5	-2458,3	-2007,6	-1462,5	-2839,0	8,3	32,7	17,1	16,4	18,3	1413,6	1506,4	21,1	48,2	31,2	30,5	32,6	9628,3
V	0,647	-1101,0	1722,0	-3713,0	-1883,0	-1496,0	-2283,0	33,8	83,0	75,0	46,1	48,5	853,2	1239,5	71,7	126,4	119,2	86,0	86,6	0,0

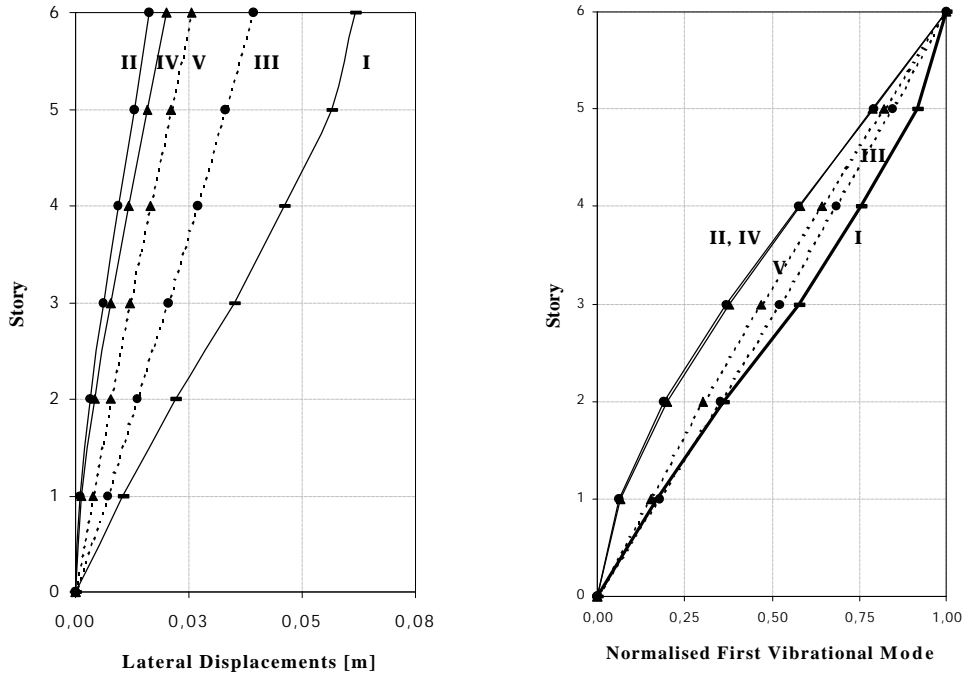

Figure 5

columns are not higher than the corresponding axial forces in bare frame case. On the other hand, in case **V** which is another shear wall with hinge connection to the foundation indicates that the axial forces in adjacent columns may increase substantially. It is interesting to note that the lateral displacements and story drifts are better controlled in the case **V** in comparison to case **III** which is good at least for imparting less earthquake forces to the buildings, Figure 5.

The nonlinear behaviour of the frames given in Figure 4 will be more explanatory if they are obtained realistically with better mathematical models for which additional works are needed. As a matter of fact, pure shear tests of different kind of panels have been tested in STEELAB to have improvement in plane stress elements which can be better used for shear walls. The experimental and associated theoretical works done in this field of interest is presented below.

NONLINEAR ANALYSES OF STRUCTURES WITH SHEAR DOMINANT ELEMENTS

The frame structures with shear walls and rigidly connected site fabricated panel building are of interest in STEELAB. A part of the general approach summarised below is being developed to have, theoretically, the nonlinear behaviour of the specimens tested.

Experimental Works

In these tests, the diagonal loads on square specimens have been distributed along the edge of specimens to reflect the pure shear stress-strain field as much as possible and the shortening and elongation of diagonals have been recorded, Figure 6. The collected data have been converted to shear stress-strain relationship, Figure 9.

The experimental background of the theoretical work summarised below is based on the results of pure shear tests carried out previously [2]. A complementary experimental work which consists of 8 similar tests for low strength unreinforced and lightly reinforced panels is going on to have better understanding for shear stress-shear strain relationship, Figure 7.

Theoretical Works and Linearisation of The Problem

Plane stress linear finite elements have been employed to represent the structural behaviour of the model given in Figure 11 which is loaded by constant vertical loads and is subjected to incremental lateral loads. Elasticity matrix,

$$D = \frac{E}{1-\mathbf{n}^2} \begin{bmatrix} 1 & \mathbf{n} & 0 \\ \mathbf{n} & 1 & 0 \\ 0 & 0 & R^*(1-\mathbf{n})/2 \end{bmatrix} \quad (1)$$

is used to reflect the material non-linearity in the analysis by means of the R factor which is a *reduction factor* given in terms of the shear strain. If the initial shear stiffness is designated as G_0 , Figure 8, then at the (i) th step which corresponds to the specific shear strain at this step, the reduction factor R_i will be

$$R_i = \frac{G_i}{G_0} \quad (2)$$

The step $(i+1)$ will start with the shear modulus of R_i and depending on \mathbf{t}_{i+1} and corresponding \mathbf{g}_{i+1} an iteration is set up to come up with a better G_{i+1} estimation for that finite element. And similar check is done for all elements for each load increment.

The experimental shear stress and shear strain behaviour obtained for the panels, Figure 6, consist of fabricated double layer steel cage and shotcrete layers are given in Figure 9 and the reduction factor developed for this material is presented in Figure 10.

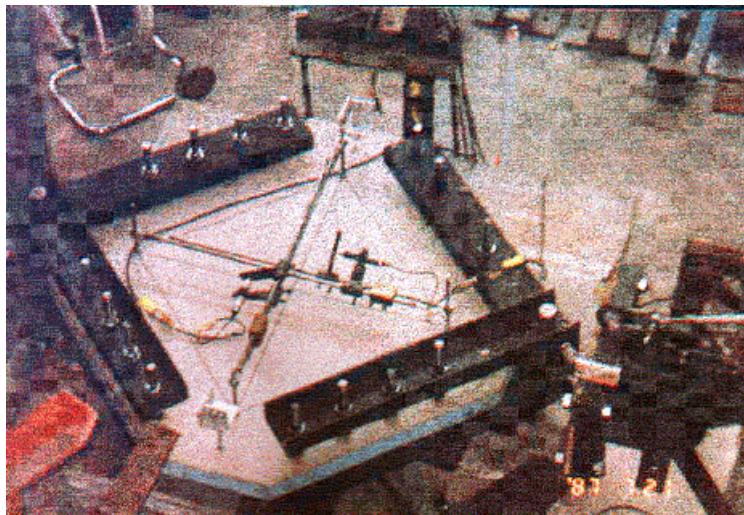
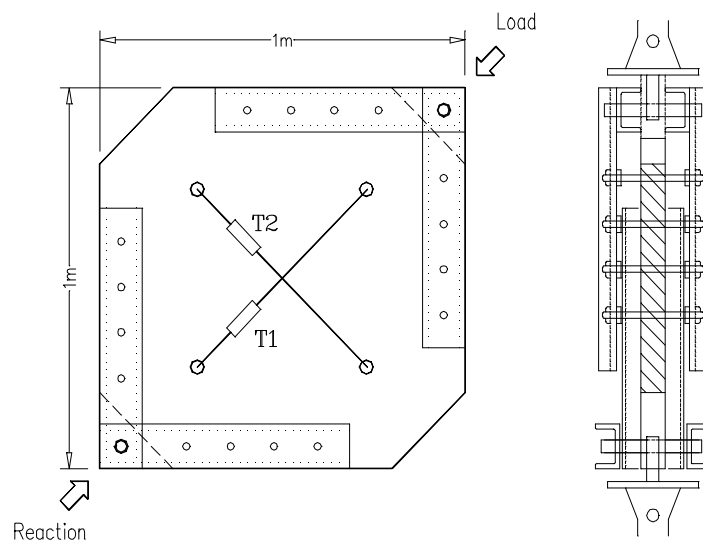
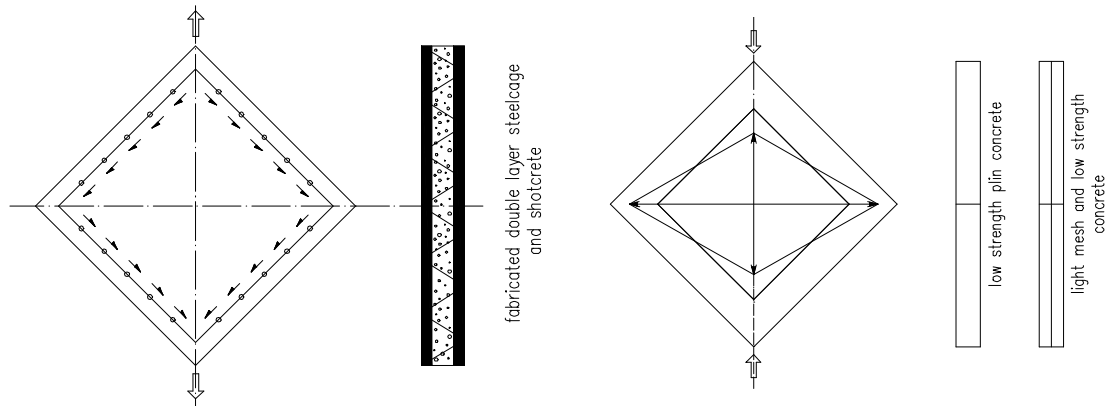

Figure 6

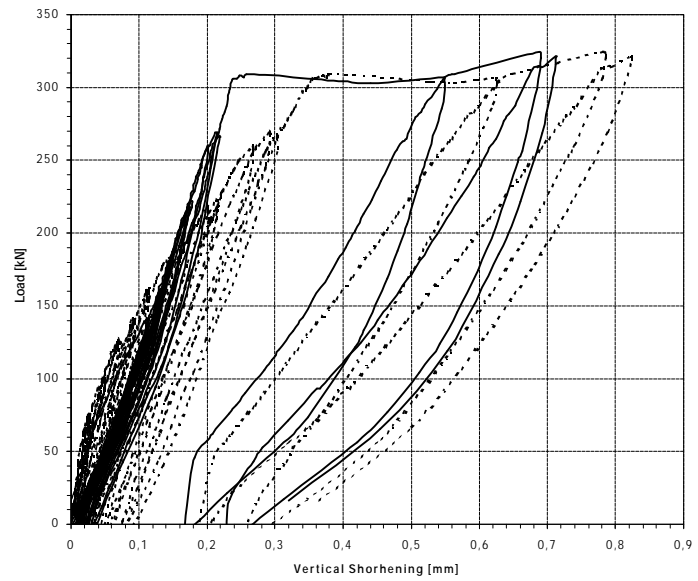

Figure 7

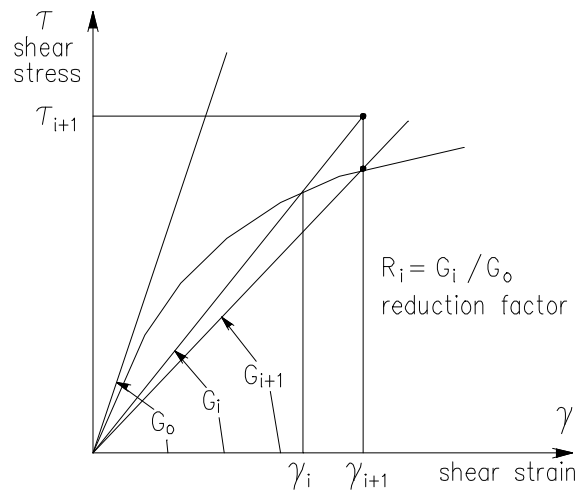

Figure 8

The 3D, 1/2 scale, one storey specimen shown in Figure 11 has been tested under monotonic static loads and the lateral displacements which have been recorded during the tests are plotted in Figure 12 together with theoretical results achieved by three different approaches based on three set of R factors presented in Figure 10.

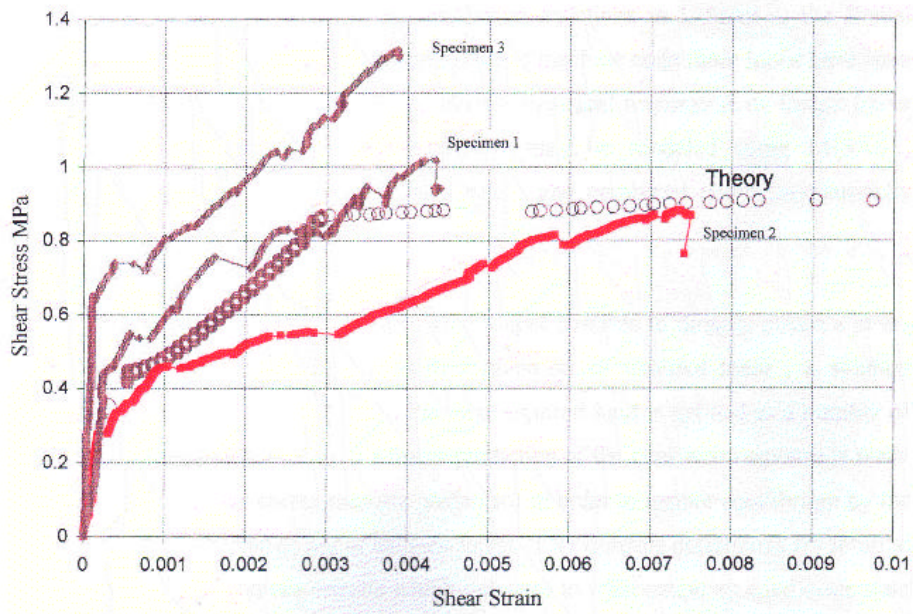

Figure 9

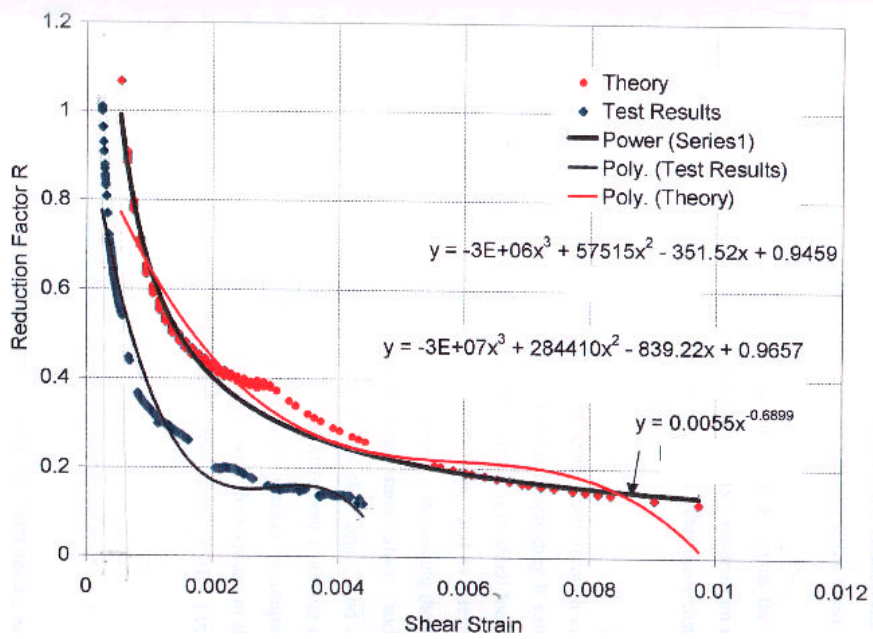

Figure 10

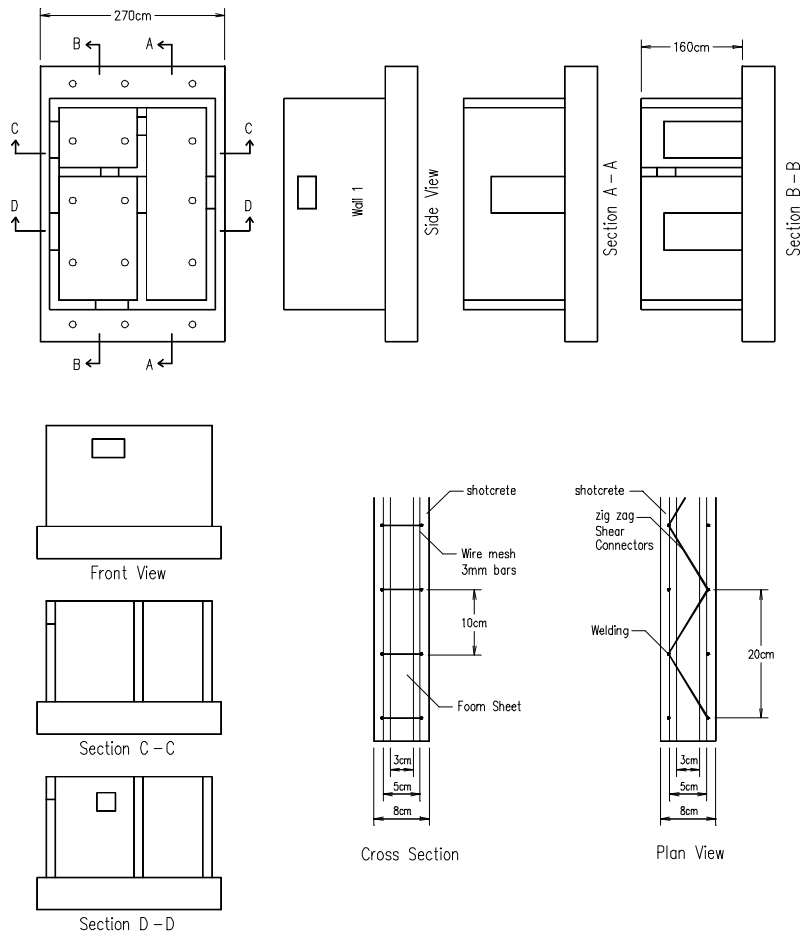

Figure 11

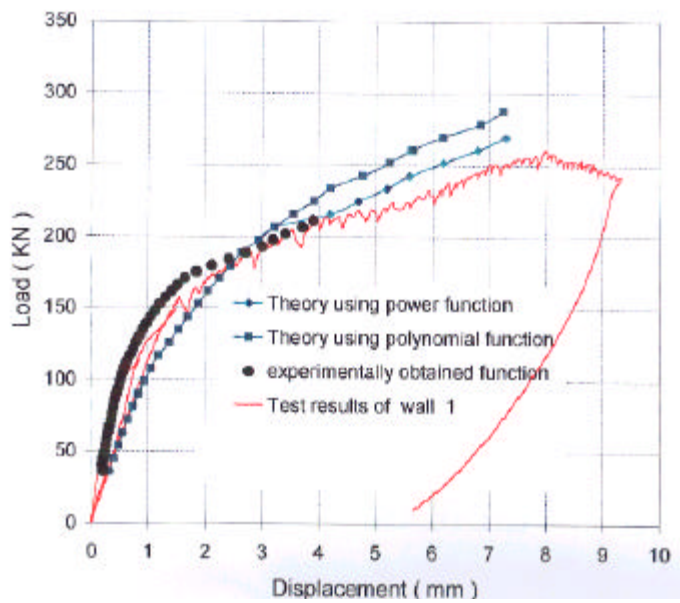

Figure 12

It should not be forgotten that these tests have been conducted under monotonic tensile or compression tests and may need modification prior to be used for the analyses of structures subjected to cyclic loading.

CONCLUSIONS

The following conclusions can be achieved at the end of this summary;

1. Not only the techniques to create new shear walls in the low cost reinforced concrete vulnerable buildings, but their connections to the peripheral elements and to foundation should be reviewed as well.
2. New shear walls are not necessarily be fixed to the foundation. The design should be done accordingly and the axial force increments should be checked in adjacent columns.
3. Shear walls can be quite well represented in a nonlinear analyses by means of a smeared plane stress rectangular elements if a reduction factor for shear deformation is defined in the elasticity matrix.
4. Although there are technical difficulties in experimental works, the reduction factor can be defined by monotonic pure shear tests. But the results should be improved through cyclic tests.
5. Cooperative experimental and theoretical research is inevitable to develop quick and reliable answers to the problems dealt with in this paper.

REFERENCES

- [1] Mourtaja W, Karadogan F, Yuksel E, Ilki A, Balcý A, "3D Behaviour of Shotcreted Light Weight Panel Buildings", 12 WCEE 2000, New Zealand.
- [2] Mourtaja W., "Use of Shotcreted Panels For Strengthening and Construction of Low Rise Buildings", Ph.D. Thesis Submitted to Istanbul Technical University, December 2000.
- [3] Proceedings of the European Workshop on the Seismic Behaviour of Asymmetric and Setback Structures, Edited by R. Ramasco and A. Rutenberg, Italy, 1996.
- [4] SAP2000 Static and Dynamic Finite Element Analysis of Structures, Computer and Structure, Inc.

APPENDIX # 1

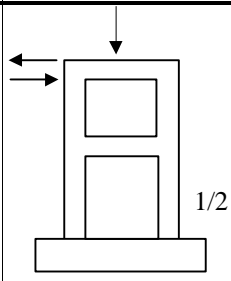
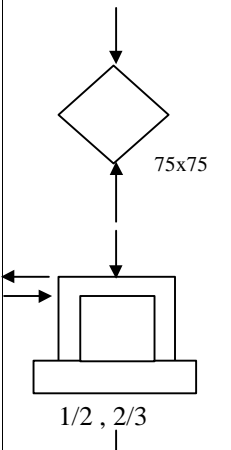
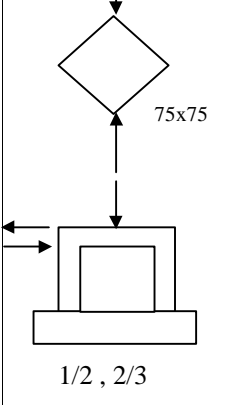
Project Number	Short Description of the Project	Additional Information		
		Number of Specimen	Source of Fund	Sketch and Scale of Specimen
1	One bay two storey infilled by brittle brick specimen will be retrofitted from one side by means of carbon fibre and be subjected to cyclic displacement reversals.	2 x 5	NATO	
2	Panel test will be carried out for the first stage of this investigation to collect the basic mechanical properties of specially reinforced infills. The same material will be used in frames with two scale and be tested. Mainly lateral reinforcement will be used in mortar layers.	32 16		
3	Panels made of brittle bricks with two different thickness, covered and uncovered by plaster and/or carbon fibers will be subjected to shear first and frames with two different scales will be tested by the help of computer controlled actuators.	28 13	SIKA	

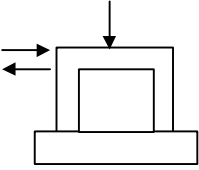
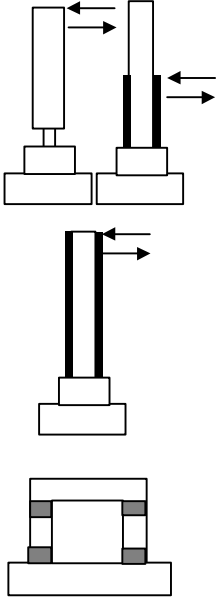
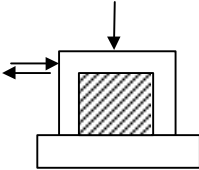
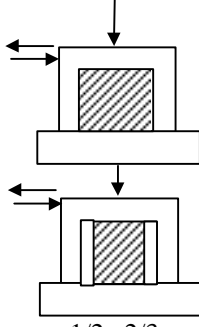
4	<p>Damaged RC frames will be strengthened by two different type of diaphragms namely fully integrated and partially integrated to the beams only. Asymmetric layers of retrofitting by shotcrete will be the other parameters of this investigation.</p>	7 + 4	TOTAL	 <p>1/2 , 2/3</p>
5 6	<p>Repair and Strengthening of prefabricated columns by means of self leveling concrete and carbon fiber sheets. Stress-strain relationship of self leveling concrete confined by different type of lateral reinforcement</p>	2 + 12 + 1	Turkish Union of Prefabrication and La Farge	
7	<p>The earthquake behavior of frames with brick walls totally integrated to the surrounding RC element during the construction stage, will be compared with the behavior of bare frame and frame with infill partitioning wall. Scale factor will be the second major parameter which will be dealt with</p>	5 + 3 + 3	agreed on but not fixed yet	 <p>1/2 , 2/3</p>
8	<p>Different type of infill walls integrated only to the beams of an RC frame will be tested together with two reference frames. High strength bricks with or without reinforcement, aerated concrete blocks, prefabricated panels in vertical and horizontal directions will be used for strengthening purpose.</p>	21 + 6	civil engineers from private sector	 <p>1/2 , 2/3</p>

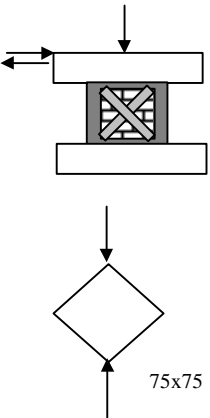
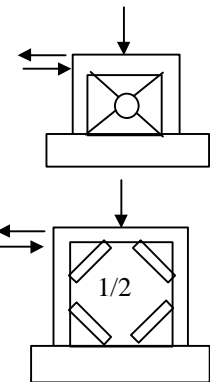
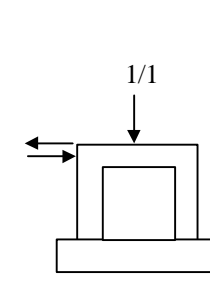
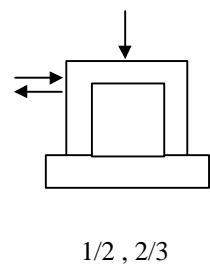
<p>9</p>	<p>Walls made by masonry bricks and concrete will be externally reinforced by steel sheets and be tested under the effects of displacement reversals. Panel tests will be carried out for obtaining the basic mechanical properties.</p>	<p>12 + 26</p>	<p>agreed on but not fixed yet</p>	
<p>10</p>	<p>Special diagonal and off diagonally braced steel frames will be tested under the cyclic displacement reversals.</p>	<p>7</p>	<p>agreed on but not fixed yet</p>	
<p>11</p>	<p>Prefabricated interlocked panels will be used as infill walls for strengthening the existing RC buildings. This will be a cooperative work with Bosphorus University.</p>	<p>6</p>	<p>agreed on but not fixed yet</p>	
<p>12</p>	<p>Brittle brick unreinforced partitioning walls will be improved by wire-mesh and shotcrete application and be tested under the cyclic displacement reversals</p>	<p>8</p>	<p>Turkish Earthquake Foundation</p>	

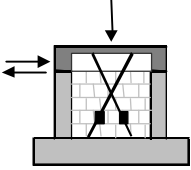
<p>13</p>	<p>Off diagonally braced reinforced concrete frames will be subjected to the cyclic displacement reversals. Post tensioning by turn buckles will be applied to the tension bars prior to the tests.</p>	<p>4 + 4</p>	<p>agreed on but not fixed yet</p>	
<p>14</p>	<p>Frames with and without corroded rebars will be tested in a long term experimental program in three different stages.</p>	<p>3 + 3 + 3</p>	<p>DEITERMANN</p>	